

HCD

Hart Concrete Design
(866) 716-4278

Item: COLUMN BASE
DINING TABLE
Material: CONCRETE TOP
WITH CONCRETE LEGS
Date: 01/26/2023

- Size:**
- 72" X 38" X 30"H
 - 84" X 42" X 30"H
 - 96" X 42" X 30"H
 - 108" X 42" X 30"H

- Select Desired Color:**
- WHITE
 - GREY
 - IRON
 - STEEL
 - MALIBU
 - IDAHO
 - MESA

- Skirt (S):**
- 2"
 - 3"
 - OTHER: _____

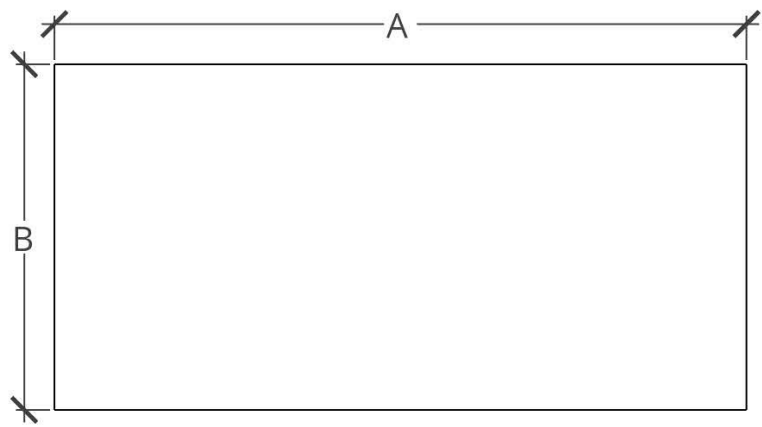

PLAN VIEW

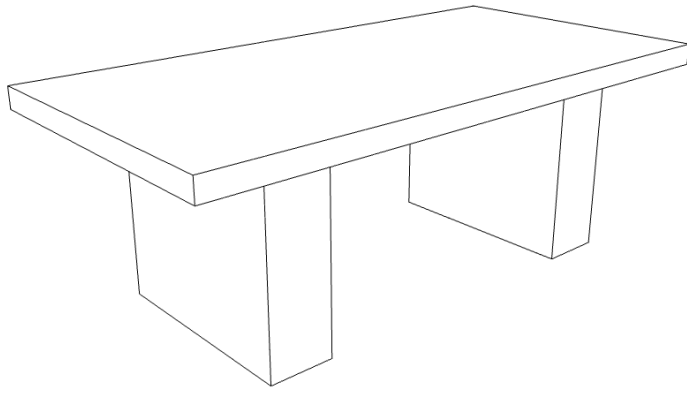

PERSPECTIVE

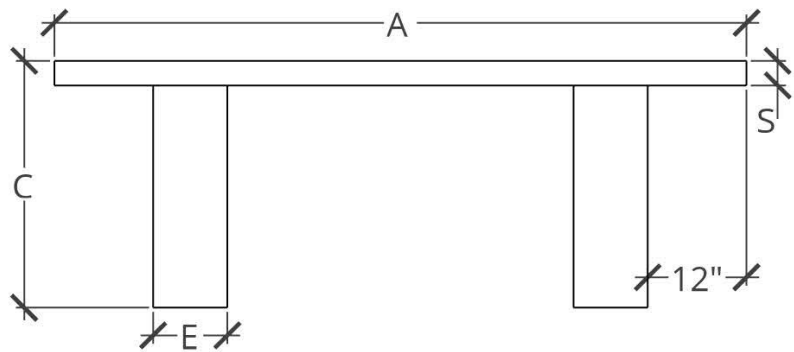

FRONT ELEVATION

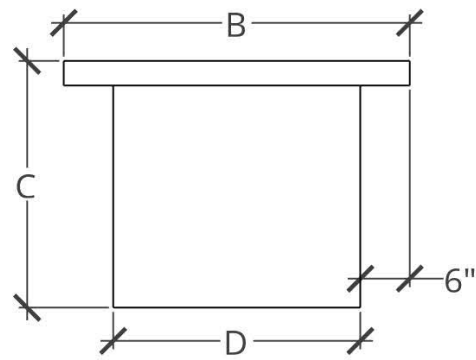

SIDE ELEVATION

DIMENSIONS (A X B X C)	LEG DIMENSIONS (D X E)	TOP WEIGHT	LEG WEIGHT
72" X 38" X 30"H	26" X 9"	250 LBS	175 LBS EACH
84" X 42" X 30"H	30" X 9"	300 LBS	200 LBS EACH
96" X 42" X 30"H	30" X 9"	350 LBS	200 LBS EACH
108" X 42" X 30"H	30" X 9"	400 LBS	200 LBS EACH

HCD

Hart Concrete Design
(866) 716-4278

Item: WATERFALL BENCH
Date: 01/10/2023

- Size:**
- 36" X 18" X 18"H
 - 48" X 18" X 18"H
 - 60" X 18" X 18"H
 - 66" X 18" X 18"H
 - 72" X 18" X 18"H
 - 84" X 18" X 18"H
 - OTHER: _____

- Select Desired Color:**
- WHITE
 - GREY
 - IRON
 - STEEL
 - MALIBU
 - IDAHO
 - MESA

- Thickness**
- 2"
 - OTHER: _____

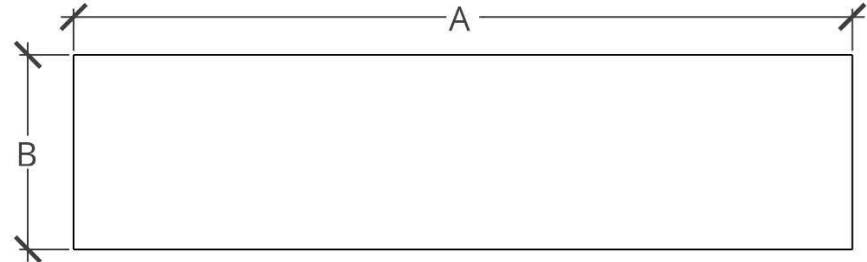

PLAN VIEW

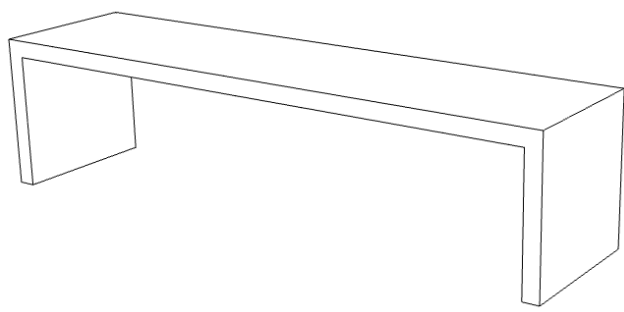

PERSPECTIVE

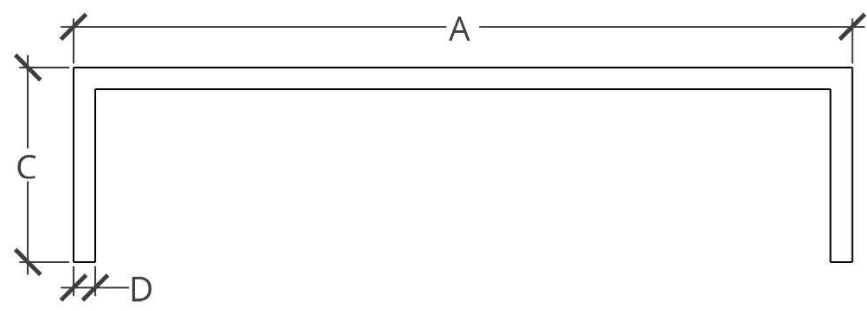

FRONT ELEVATION

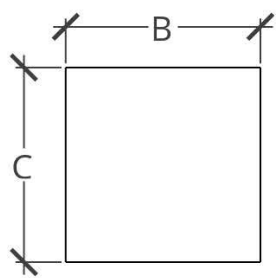

SIDE ELEVATION

DIMENSIONS (A X B X C)	THICKNESS (D)	WEIGHT
66" X 18" X 18"H	2"	275 LBS
72" X 18" X 18"H	2"	300 LBS
84" X 18" X 18"H	2"	325 LBS